

M12 male connectors with cable



Features:

- Polyurethane connector body
- Class 6 copper conductors acc. to IEC 60228 - mobile installation
- Gold-plated contacts
- Self-locking ring nut
- High flexibility cable with oil resistant PVC or PUR sheath suitable to be used in drag chains, acc. to IEC 60332-1-2

Max. operating voltage:	250 Vac / 300 Vdc (5-pole) 30 Vac / 36 Vdc (8-pole)
Max. operating current:	4 A (5-pole) 2 A (8-pole)
Protection degree:	IP67 acc. to EN 60529 IP69K acc. to ISO 20653 (Protect the cables from direct high-pressure and high-temperature jets)
Ambient temperature:	-25°C ... +80°C for fixed installation -15°C ... +80°C for mobile installation
Wire cross-sections:	0.25 mm ² (23 AWG)
Minimum bending radius:	> cable diameter x 15
Tightening torque of the ring:	0.6 ... 0.8 Nm

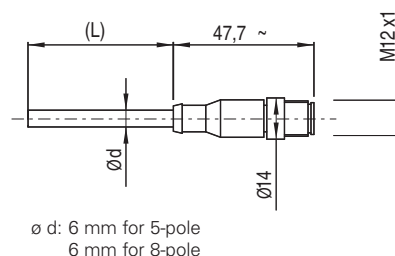

Pin assignment

5 poles		8 poles	
Pin	Colour	Pin	Colour
1	Brown	1	White
2	White	2	Brown
3	Blue	3	Green
4	Black	4	Yellow
5	Grey	5	Grey
		6	Pink
		7	Blue
		8	Red

Code structure

Attention! The feasibility of a code number does not mean the effective availability of a product. Please contact our sales office.

VF CF5PD3M

No. of poles		Connection type	
5	5 poles	M	M12x1
8	8 poles		
Cable length (L)		Cable sheath	
3	3 metres (standard)	P	PVC (standard)
5	5 metres	U	PUR
0	10 metres		
Other lengths on request		Connector type	
		D	straight

Stock items

VF CF5PD3M
VF CF8PD3M

Attention! For items not in stock the minimum order quantity is 100 pcs.

ATTENTION: always disconnect the power supply before removing the connector. The connector is not suitable for separation of electrical loads.

All values in the drawings are in mm

→ The 2D and 3D files are available at www.pizzato.com

M12 female connectors with cable



Features:

- Polyurethane connector body
- Class 6 copper conductors acc. to IEC 60228 - mobile installation
- Gold-plated contacts
- Self-locking ring nut made of nickel-plated brass, available on request in AISI 316L stainless steel hex version.
- High flexibility cable with oil resistant PVC or PUR sheath suitable to be used in drag chains, acc. to IEC 60332-1-2

Max. operating voltage:	250 Vac / 300 Vdc (4/5-pole) 30 Vac / 36 Vdc (8/12-pole)
Max. operating current:	4 A (4-5-pole); 2 A (8-pole); 1.5 A (12-pole)
Protection degree:	IP67 acc. to EN 60529, IP69K acc. to ISO 20653 (Protect the cables from direct high-pressure and high-temperature jets)
Ambient temperature:	-25°C ... +80°C, PVC sheath, fixed installation -15°C ... +80°C, PVC sheath, mobile installation -40°C ... +80°C, PUR sheath, fixed installation -25°C ... +80°C, PUR sheath, mobile installation
Wire cross-sections:	0.34 mm ² (22 AWG) for 4-pole 0.25 mm ² (23 AWG) for 5/8-pole 0.14 mm ² (26 AWG) for 12-pole
Minimum bending radius:	> cable diameter x 15
Tightening torque of the ring:	0.6 ... 0.8 Nm

Pin assignment

4 poles		5 poles		8 poles		12 poles	
Pin	Colour	Pin	Colour	Pin	Colour	Pin	Colour
1	Brown	1	Brown	1	White	1	Brown
2	White	2	White	2	Brown	2	Blue
3	Blue	3	Blue	3	Green	3	White
4	Black	4	Black	4	Yellow	4	Green
		5	Grey	5	Grey	5	Pink
				6	Pink	6	Yellow
				7	Blue	7	Black
				8	Red	8	Grey
						9	Red
						10	Purple
						11	Grey-Pink
						12	Red-Blue

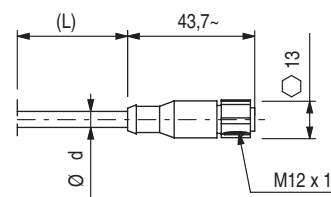
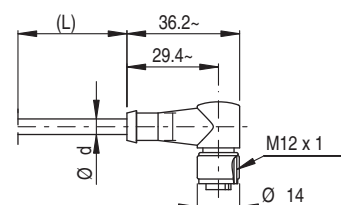
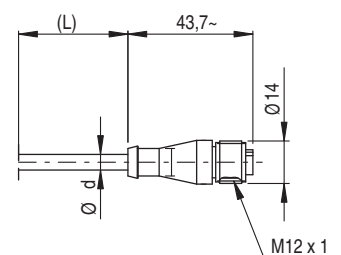

Ø d: 5 mm for 4 and 5-pole
6 mm for 8 and 12 poles

Code structure

Attention! The feasibility of a code number does not mean the effective availability of a product. Please contact our sales office.

article options
VF CA4PD3M-X

No. of poles	
4	4 poles
5	5 poles
8	8 poles
12	12 poles

Cable sheath	
P	PVC (standard)
U	PUR

Connector type	
D	straight (standard)
G	angled

Connection type		Fixing ring	
M	M12x1		knurled ring (standard)
		X	stainless steel hex ring nut

Cable length (L)		4 poles	5 poles	8 poles	12 poles
1	1 metre				
2	2 metres				
3	3 metres (standard)	•	•		
4	4 metres				
5	5 metres (standard)	•	•	•	•
...					
0	10 metres (standard)	•	•	•	•

Other lengths on request

Stock items

VF CA4PD3M
VF CA4PD5M
VF CA4PD0M
VF CA5PD3M
VF CA5PD5M
VF CA5PD0M
VF CA8PD5M
VF CA8PD0M
VF CA12PD5M
VF CA12PD20M
VF CA12PD30M
VF CA12PD0M
VF CA8UD5M-X
VF CA8UD0M-X
VF CA12UD0M-X

Attention! For items not in stock the minimum order quantity is 100 pcs.

ATTENTION: always disconnect the power supply before removing the connector. The connector is not suitable for separation of electrical loads.

All values in the drawings are in mm

→ The 2D and 3D files are available at www.pizzato.com

M12 male connectors



Features:

- Technopolymer or metal connector body
- Gold-plated contacts
- Wires with crimped ferrules
- Directly installable on the device, these ensure quick replacement, reducing machine down time

Max. operating voltage:	250 Vac / 300 Vdc (4/5-pole) 30 Vac / 36 Vdc (8/12-pole)
Max. operating current:	4 A (4/5-pole) 2 A (8-pole) 1.5 A (12-pole)
Protection degree:	IP67 acc. to EN 60529 IP69K acc. to ISO 20653
Ambient temperature:	-25°C ... +80°C
Tightening torque:	1 ... 1.5 Nm
Wire cross-sections:	0.5 mm ² (20 AWG) for 4/5-pole 0.25 mm ² (23 AWG) for 8-pole 0.14 mm ² (26 AWG) for 12-pole
Contact type:	gold-plated

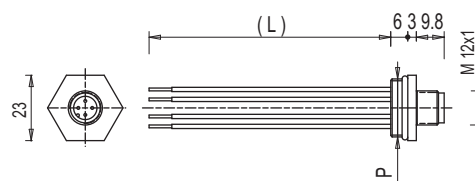

Pin assignment

4 poles		5 poles		8 poles		12 poles	
Pin	Colour	Pin	Colour	Pin	Colour	Pin	Colour
1	Brown	1	Brown	1	White	1	Brown
2	White	2	White	2	Brown	2	Blue
3	Blue	3	Blue	3	Green	3	White
4	Black	4	Black	4	Yellow	4	Green
		5	Grey	5	Grey	5	Pink
				6	Pink	6	Yellow
				7	Blue	7	Black
				8	Red	8	Grey
						9	Red
						10	Purple
						11	Grey-Pink
						12	Red-Blue

Code structure

Attention! The feasibility of a code number does not mean the effective availability of a product. Please contact our sales office.

article		options	
VF CNM5MM-L100			
Body material		Wire length (L)	
M	metal		8.5 cm (standard)
P	plastic	L16	16 cm
No. of poles		L100	100 cm
4	4 poles	L200	200 cm
5	5 poles	Connection type	
8	8 poles	M	M12x1
12	12 poles	Connector thread (P)	
		M	M20 x 1.5 (standard)
		P	PG 13.5

Stock items

VF CNP4MM
VF CNP4PM
VF CNP5MM
VF CNP5PM
VF CNP8MM
VF CNM4MM
VF CNM4PM
VF CNM5MM
VF CNM5PM
VF CNM8MM
VF CNM8PM
VF CNM12MM-L16

ATTENTION: always disconnect the power supply before removing the connector. The connector is not suitable for separation of electrical loads.

Note: the 12-pole connector is only available in metal with M20x1.5 thread and 16 cm wires.

All values in the drawings are in mm

→ The 2D and 3D files are available at www.pizzato.com

Field wireable M12 female connectors



Features:

- Technopolymer connector body
- Gold-plated contacts
- Screw terminals for cable screw fittings

Max. operating voltage:	250 Vac/dc (4 and 5-pole) 30 Vac/dc (8-pole)
Max. operating current:	4 A (4 and 5-pole) 2 A (8-pole)
Protection degree:	IP67 acc. to EN 60529
Ambient temperature:	-25°C ... +85°C
Wire cross-sections:	0.25 mm ² (23 AWG) ... 0.5 mm ² (20 AWG)
Tightening torque of the ring:	0.6 ... 0.8 Nm

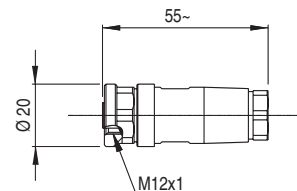

Article	Description	no. of poles
VF CBMP4DM04	Field wireable M12 female connector, straight, for Ø 4 ... Ø 6.5 mm multipolar cables	4
VF CBMP5DM04	Field wireable M12 female connector, straight, for Ø 4 ... Ø 6.5 mm multipolar cables	5
VF CBMP8DM04	Field wireable M12 female connector, straight, for Ø 4 ... Ø 7 mm multipolar cables	8

Field wireable M12 male connectors



Features:

- Technopolymer connector body
- Gold-plated contacts
- Screw terminals for cable screw fittings

Max. operating voltage:	250 Vac/dc (5-pole) 30 Vac/dc (8-pole)
Max. operating current:	4 A (5-pole) 2 A (8-pole)
Protection degree:	IP67 acc. to EN 60529
Ambient temperature:	-25°C ... +85°C
Wire cross-sections:	0.25 mm ² (23 AWG) ... 0.5 mm ² (20 AWG)
Tightening torque of the ring:	0.6 ... 0.8 Nm

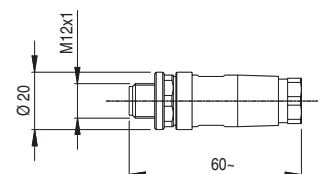

Article	Description	no. of poles
VF CCMP5DM04	Field wireable M12 male connector, straight, for Ø 4 ... Ø 6.5 mm multipolar cables	5
VF CCMP8DM04	Field wireable M12 male connector, straight, for Ø 4 ... Ø 7 mm multipolar cables	8

ATTENTION: always disconnect the power supply before removing the connector. The connector is not suitable for separation of electrical loads.

Series connection with Y-shaped M12 connectors

To facilitate and simplify the series wiring of the safety devices, a variety of accessories designed specifically for this purpose are available. With the help of the proven M12 round connector, safety equipment of Category 4, SIL3 and PL e with up to 32 elements connected in series is possible. All of which is possible without the risk of connection errors and with a high IP67 protection degree.

The safety circuits consist of a 24 Vdc power supply unit, a number of extensions to the installed devices, Y connectors for branching out from the chain to each individual device and a terminating plug.

In addition to the power supply unit, a suitable safety module is used to assess the state of the safety outputs within the safety chain.

Devices suitable for series connection

The series may consist both of devices that are identical to one another (homogeneous series) or that belong to different series (mixed series).

The following Pizzato Elettrica devices may be connected in series using the Y connectors.

- ST series RFID safety sensors: ST ●●31●M●, ST ●●71●M●.
- NG series RFID safety switches with lock: NG ●●●●●●-K950, NG ●●●●●●-K951, NG ●●●●●●-K952.
- NS series RFID safety switches with lock: NS ●●●●●●Q●.
- HX series safety hinge switches: HX BEE1-●●M.

Electrical connection of the chain

Pin	Colour	Connection
1	Brown	A1 Supply input +24 Vdc
2	White	OS1 Safety output
3	Blue	A2 Supply input 0 V
4	Black	OS2 Safety output
5	Grey	I4 Solenoid activation input

Note: By activating/deactivating input I4, all switches of the NG and NS series in the chain simultaneously block/open all guards. Activation and deactivation of input I4 has no effect on the ST sensors and HX hinges in the chain.

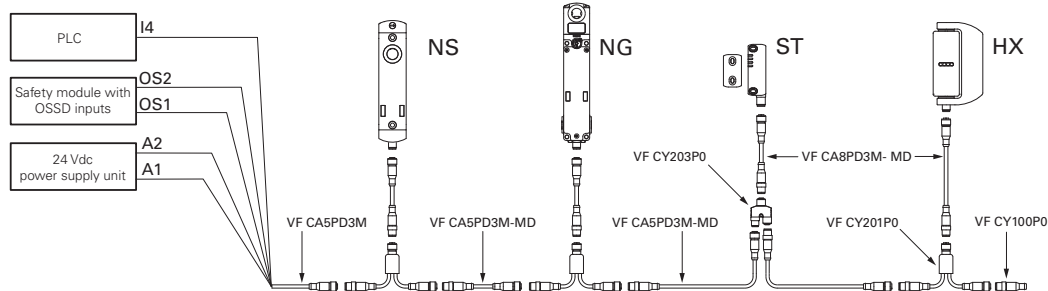

- **Attention!** For proper operation of the devices connected in series via cables or Y connectors, it is necessary to pay particular attention to the voltage drop that occurs in the circuit. Pay particular attention to the currents and cross-sections/lengths of the used cables to ensure that the supply voltage of the components at the end of the series connection remains within the specified limit values during effective operation.

M12 male-female connectors with cable



Features:

- Polyurethane connector body
- Class 6 copper conductors acc. to IEC 60228
- Gold-plated contacts
- Self-locking ring nut
- High flexibility cable with oil resistant PVC sheath suitable to be used in drag chains, acc. to IEC 60332-1-2

Max. operating voltage:	250 Vac / 300 Vdc (5-pole) 30 Vac / 36 Vdc (8-pole)
Max. operating current:	4 A (5-pole), 2 A (8-pole)
Protection degree:	IP67 acc. to EN 60529 IP69K acc. to ISO 2653 (Protect the cables from direct high-pressure and high-temperature jets)
Ambient temperature:	-25°C ... +80°C for fixed installation -15°C ... +80°C for mobile installation
Wire cross-sections:	0.5 mm ² (20 AWG) (5-pole) 0.25 mm ² (23 AWG) (8-pole)
Minimum bending radius:	> cable diameter x 15
Tightening torque of the ring:	0.6 ... 0.8 Nm

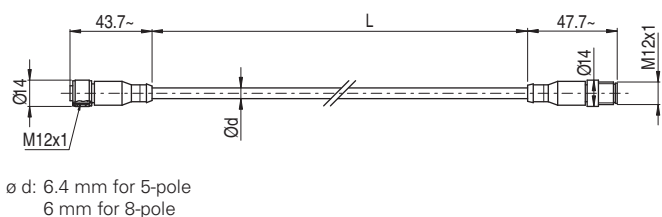

ø d: 6.4 mm for 5-pole
6 mm for 8-pole

Code structure

VF CA5PD3M-MD

No. of poles	5 poles	8 poles	Connection type	M M12x1
Cable length (L)	3 metres (standard)	5 metres (standard)	No. of poles	5 8
Cable sheath	P PVC	0 10 metres (standard)		
Connector type	D straight	Other lengths on request		

Pin assignment

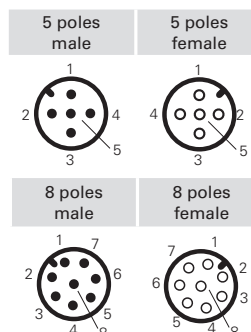

Stock items

VF CA5PD3M-MD
VF CA5PD5M-MD
VF CA5PD0M-MD
VF CA8PD3M-MD
VF CA8PD5M-MD

Attention! For items not in stock the minimum order quantity is 100 pcs.

ATTENTION: always disconnect the power supply before removing the connector. The connector is not suitable for separation of electrical loads.

All values in the drawings are in mm

→ The 2D and 3D files are available at www.pizzato.com

M12 connectors, Y-shaped, for series connections



Article	Description
VF CY201P0	M12 connector, Y-shaped, for series connections with 150 mm cable length

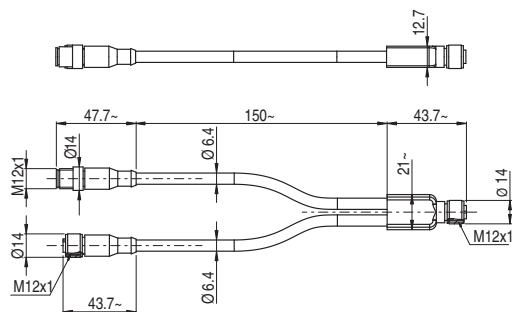

Features:

- Polyurethane connector body
- Gold-plated contacts
- Self-locking ring nut
- Class 6 copper conductors acc. to IEC 60228
- High flexibility cable with oil resistant PVC sheath suitable to be used in drag chains, acc. to IEC 60332-1-2



Article	Description
VF CY203P0	M12 connector, Y-shaped, for series connections without cable

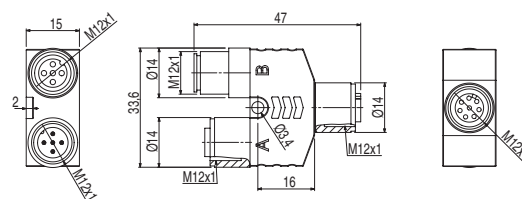

Max. operating voltage:	30 Vac / 36 Vdc
Max. operating current:	4 A (5-pole) 2 A (8-pole)
Protection degree:	IP67 acc. to EN 60529
Ambient temperature:	-25°C ... +80°C for fixed installation -15°C ... +80°C for mobile installation
Wire cross-sections:	0.5 mm ² (20 AWG)
Minimum bending radius:	> cable diameter x 15
Tightening torque of the ring:	0.6 ... 0.8 Nm

Internal block diagram, Y-shaped connector

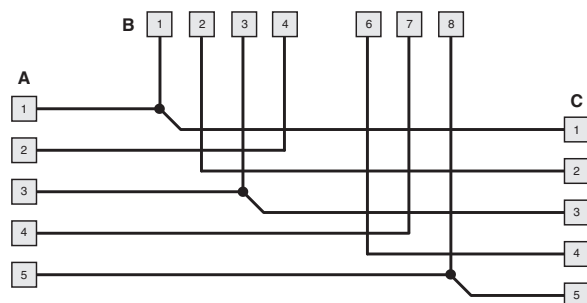

Pin assignment

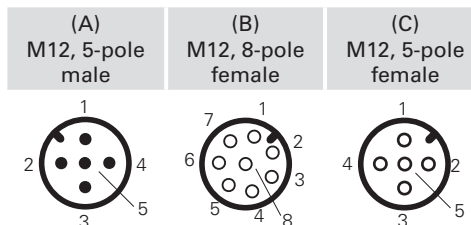

IMPORTANT: When used in safety applications, the Y connectors must be installed in a location that is not directly accessible, so as to avoid shocks or tampering.

M12 terminating plugs for series connections



Features:

- Polyurethane connector body
- Gold-plated contacts
- Self-locking ring nut

Max. operating voltage:	250 Vac / 300 Vdc
Max. operating current:	4 A
Protection degree:	IP67 acc. to EN 60529
Tightening torque of the ring:	0.6 ... 0.8 Nm

Article	Description
VF CY100P0	M12 terminating plugs for series connections, 4-pole

Pin assignment

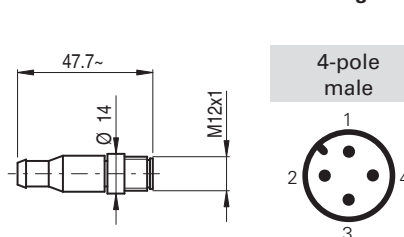

Internal block diagram of the terminating plug

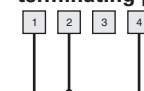

M23 male connectors



Features:

- Threaded connection M20 for installation on switches with M20 cable entry (for example: FG series and NG series)
- Nickel-plated metal connector body
- Gold-plated contacts
- 12-pole or 19-pole versions
- Wires with pre-insulated ferrules
- Directly installable on the device, these ensure quick replacement, reducing machine down time

Max. operating voltage:	250 Vac (12-pole) 100 Vac (19-pole)
Max. operating current:	3 A
Protection degree:	IP67 acc. to EN 60529 IP69K acc. to ISO 20653
Ambient temperature:	-25°C ... +80°C
Tightening torque:	1 ... 1.5 Nm
Wire cross-section:	0.34 mm ² (22 AWG)
Contact type:	gold-plated

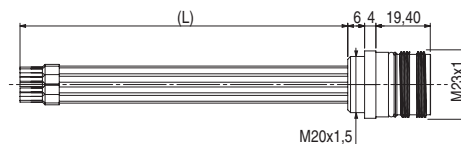
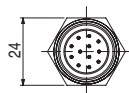

Pin assignment

12 poles

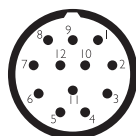

19-pole

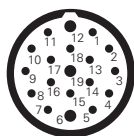

Pin	Colour	Pin	Colour	Pin	Colour
1	White	1	White	13	White-Green
2	Brown	2	Brown	14	Brown-Green
3	Green	3	Green	15	White-Yellow
4	Yellow	4	Yellow	16	Yellow-Brown
5	Grey	5	Grey	17	White-Grey
6	Pink	6	Pink	18	Grey-Brown
7	Blue	7	Blue	19	White-Pink
8	Red	8	Red		
9	Black	9	Black		
10	Purple	10	Purple		
11	Grey-Pink	11	Grey-Pink		
12	Red-Blue	12	Red-Blue		

Code structure

Attention! The feasibility of a code number does not mean the effective availability of a product. Please contact our sales office.

VF CNM12MT-L10

Body material

M metal

Wire length (L)

L10 10 cm

L16 16 cm

No. of poles

12 12 poles

19 19-pole

Note

For applications with NG series switches, use connectors with L10 wire length.
For applications with FG series switches, use connectors with L16 wire length.

ATTENTION: always disconnect the power supply before removing the connector. The connector is not suitable for separation of electrical loads.

All values in the drawings are in mm

→ The 2D and 3D files are available at www.pizzato.com

M23 female connectors with cable



Features:

- Polyurethane connector body
- Class 5 copper conductors acc. to VDE 0295 (12-pole)
- Class 2 copper conductors acc. to VDE 0295 (19-pole)
- Gold-plated contacts
- Self-locking ring nut
- Cable with PVC sheath acc. to IEC 60332-3, CEI 20-22 II e CEI 20-35/1-2 (flame retarding)

Max. operating voltage:	250 Vac (12-pole) 100 Vac (19-pole)
Max. operating current:	3 A
Protection degree:	IP67 acc. to EN 60529 IP69K acc. to ISO 20653 (Protect the cables from direct high-pressure and high-temperature jets)
Ambient temperature:	-5°C ... +70°C
Wire cross-sections:	0.5 mm ² (20 AWG) (12-pole) 0.34 mm ² (22 AWG) (19-pole)
Minimum bending radius:	> cable diameter x 15
Tightening torque of the ring:	1 ... 1.5 Nm

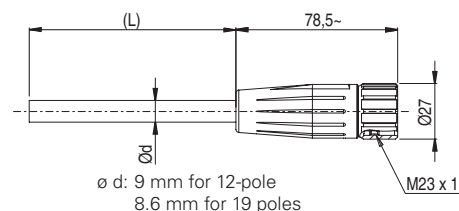

Pin assignment

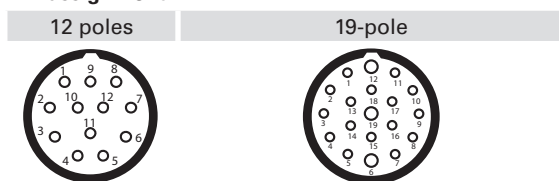

Pin	Colour	Pin	Colour	Pin	Colour
1	White	1	White	13	White-Green
2	Brown	2	Brown	14	Brown-Green
3	Green	3	Green	15	White-Yellow
4	Yellow	4	Yellow	16	Yellow-Brown
5	Grey	5	Grey	17	White-Grey
6	Pink	6	Pink	18	Grey-Brown
7	Blue	7	Blue	19	White-Pink
8	Red	8	Red		
9	Black	9	Black		
10	Purple	10	Purple		
11	Grey-Pink	11	Grey-Pink		
12	Red-Blue	12	Red-Blue		

Code structure

Attention! The feasibility of a code number does not mean the effective availability of a product. Please contact our sales office.

VF CA12PD20S

No. of poles		Connection type	
12	12 poles	S	M23x1
19	19-pole		
Cable sheath		Cable length (L)	
P	PVC	0	10 metres
		20	20 metres
		Other lengths on request	
Connector type			
D	straight		

Stock items

VF CA12PD0S
VF CA12PD20S
VF CA19PD0S
VF CA19PD20S

Attention! For items not in stock the minimum order quantity is 50 pcs.

ATTENTION: always disconnect the power supply before removing the connector. The connector is not suitable for separation of electrical loads.

All values in the drawings are in mm

→ The 2D and 3D files are available at www.pizzato.com

Field wireable M23 female connectors



Features:

- Nickel-plated metal connector body
- Gold-plated contacts
- 12-pole or 19-pole versions

Max. operating voltage:	250 Vac (12-pole) 100 Vac (19-pole)
Max. operating current:	8 A
Protection degree:	IP67 acc. to EN 60529 IP69K acc. to ISO 20653
Ambient temperature:	-40°C ... +125°C
Tightening torque of the ring:	1 ... 1.5 Nm
Pollution degree:	3
Switching cycles:	> 1000

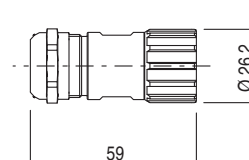

Pin configuration

12 poles



clockwise numbering

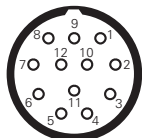

counterclockwise numbering

19-pole

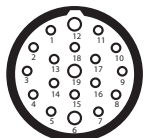

clockwise numbering



Article	Description
VF AC2205	Mounting key

Note: Article required for opening and wiring the connector

Code structure

Attention! The feasibility of a code number does not mean the effective availability of a product. Please contact our sales office.

VF CBSM12TC07

Connection type

S M23x1

Body material

M metal

No. of poles

12 12 poles

19 19-pole

Connector type

T clockwise numbering (standard)

D counterclockwise numbering

Cable diameter

07 Ø 7 ... Ø 12 mm

Pin connection type

C crimp connection (standard) 0.34 ... 1 mm²

S solder connection 0.34 ... 1 mm²

Note: Use appropriate crimp pliers for crimp connections (e.g., Knipex, article number 97 52 63).

 Stock items

VF CBSM12TC07

VF CBSM19TC07

VF CBSM12TS07

M8 female connectors with cable



Features:

- Polyurethane connector body
- Class 6 copper conductors acc. to IEC 60228
- Gold-plated contacts
- Self-locking ring nut
- High flexibility cable with oil resistant PVC or PUR sheath suitable to be used in drag chains, acc. to IEC 60332-1-2

Max. operating voltage:	60 Vac / 75 Vdc
Max. operating current:	4 A
Protection degree:	IP67 acc. to EN 60529 IP69K acc. to ISO 20653 <small>(Protect the cables from direct high-pressure and high-temperature jets)</small>
Ambient temperature:	-25°C ... +80°C for fixed installation -15°C ... +80°C for mobile installation
Wire cross-sections:	0.25 mm ² (23 AWG)
Minimum bending radius:	> cable diameter x 15
Tightening torque of the ring:	0.3 ... 0.5 Nm

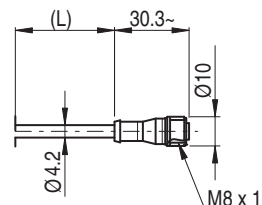

Pin assignment

4 poles

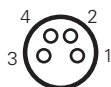

Pin	Colour
1	Brown
2	White
3	Blue
4	Black

Code structure

Attention! The feasibility of a code number does not mean the effective availability of a product. Please contact our sales office.

VF CA4PD3K

No. of poles		Connection type	
4	4 poles	K	M8x1
Cable sheath		Cable length (L)	
P	PVC (standard)	1	1 metre
U	PUR	2	2 metres
Connector type		3	3 metres (standard)
D	straight	4	4 metres
		5	5 metres (standard)
		...	
		0	10 metres

Other lengths on request

Stock items

VF CA4PD3K
VF CA4PD5K

Attention!

For items not in stock the minimum order quantity is 100 pcs.

ATTENTION: always disconnect the power supply before removing the connector. The connector is not suitable for separation of electrical loads.

All values in the drawings are in mm

→ The 2D and 3D files are available at www.pizzato.com

Strain relief cable glands

Packs of **10 pcs.**

This particular design ensures high resistance to traction of the cable glands. All cable glands are also suitable for a wide range of cable diameters.

Suitable for circular cross-section cables only.

Features:

Body and ring material: technopolymer without halogen
 Protection degree: IP67 acc. to EN 60529
 Tightening torque: 3 ... 4 Nm (PG 13.5/M20)
 2 ... 2.5 Nm (PG 11/M16)

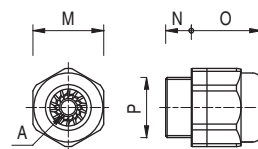

	Article	Description	A	⬡ _M	N	O	P
Metric threads	VF PAM25C7N	Cable gland M25x1.5 for a cable from Ø 10 to Ø 17 mm	○	30	10	28	M25x1.5
	VF PAM20C6N	M20x1.5 cable gland for one cable Ø 6 ... 12 mm	○	24	9	24	M20x1.5
	VF PAM20C5N	M20x1.5 cable gland for one cable Ø 5 ... 10 mm	○	24	9	24	M20x1.5
	VF PAM20C3N	M20x1.5 cable gland for one cable Ø 3 ... 7 mm	○	24	9	24	M20x1.5
	VF PAM16C5N	M16x1.5 cable gland for one cable Ø 5 ... 10 mm	○	22	7.5	23	M16x1.5
	VF PAM16C4N	M16x1.5 cable gland for one cable Ø 4 ... 8 mm	○	22	7.5	23	M16x1.5
	VF PAM16C3N	M16x1.5 cable gland for one cable Ø 3 ... 7 mm	○	22	7.5	23	M16x1.5
	VF PAM20CBN	M20x1.5 multi-hole cable gland for 2 cables Ø 3 ... 5 mm	⊗	24	9	23	M20x1.5
	VF PAM20CDN	M20x1.5 multi-hole cable gland for 3 cables Ø 1 ... 4 mm	⊗	24	9	23	M20x1.5
	VF PAM20CEN	M20x1.5 multi-hole cable gland for 3 cables Ø 3 ... 5 mm	⊗	24	9	23	M20x1.5
	VF PAM20CFN	M20x1.5 multi-hole cable gland for 4 cables Ø 1 ... 4 mm	⊗	22	9	23	M20x1.5
	PG threads	VF PAP13C6N	PG 13.5 cable gland for one cable from Ø 6 ... 12 mm	○	24	9	24
VF PAP13C5N		PG 13.5 cable gland for one cable from Ø 5 ... 10 mm	○	24	9	24	PG 13.5
VF PAP13C3N		PG 13.5 cable gland for one cable from Ø 3 ... 7 mm	○	24	9	24	PG 13.5
VF PAP11C5N		PG 11 cable gland for one cable from Ø 5 ... 10 mm	○	22	7.5	23	PG 11
VF PAP11C4N		PG 11 cable gland for one cable from Ø 4 ... 8 mm	○	22	7.5	23	PG 11
VF PAP11C3N		PG 11 cable gland for one cable from Ø 3 ... 7 mm	○	22	7.5	23	PG 11

Thread adapters

Packs of **100 pcs.**

Thread adapters make it possible to fulfil requests for switches with a different thread to those generally found in stock. This means it is possible to offer customers a single product type with various threaded connections, while only having to stock the product itself and many kinds of adapters.

Features:

Body material: glass fibre reinforced technopolymer
 Tightening torque: 3 ... 4 Nm

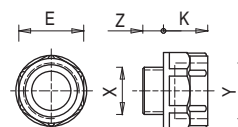

Article	Description	X	Y	Z	K	⬡ _E
VF ADPG13-PG11	Adapter from PG 13.5 to PG 11	PG 13.5	PG 11	9	12	22
VF ADPG13-M20	Adapter from PG 13.5 to M20x1.5	PG 13.5	M20x1.5	9	14	24
VF ADPG13-1/2NPT	Adapter from PG 13.5 to 1/2 NPT	PG 13.5	1/2 NPT	9	14	24
VF ADPG11-1/2NPT	Adapter from PG 11 to 1/2 NPT	PG 11	1/2 NPT	7	14	24
VF ADPG11-PG13	Adapter from PG 11 to PG 13.5	PG 11	PG 13.5	7	14	24
VF ADM20-1/2NPT	Adapter from M20 x 1.5 to 1/2 NPT	M20 x 1.5	1/2 NPT	9	14	24

Protection caps

Packs of **10 pcs.****Features:**

Body material: technopolymer, self-extinguishing
 Protection degree: IP67 acc. to EN 60529
 IP69K acc. to ISO 20653
 Tightening torque: 1.2 ... 1.6 Nm
 Cross-recessed screw: PH3

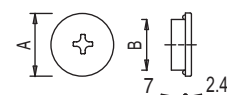

Article	Description	A	B
VF PTM20	Protection cap M20x1.5	24	M20x1.5
VF PTG13.5	Protection cap PG13.5	24	PG 13.5

Threaded nuts

Packs of **10 pcs.****Features:**

Tightening torque: 1.2 ... 2 Nm

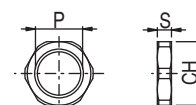

	Article	Description	S	CH	P
Plastic	VF DFPM25	M25x1.5 threaded technopolymer nut	6	32	M25x1.5
	VF DFPM20	M20x1.5 threaded technopolymer nut	6	27	M20x1.5
	VF DFPM16	M16x1.5 threaded technopolymer nut	5	22	M16x1.5
	VF DFPP13	PG13.5 threaded technopolymer nut	6	27	PG 13.5
Metal	VF DFMM20	M20x1.5 threaded nut in nickel-plated brass	3	23	M20x1.5

Chock plugs

Packs of **100 pcs.****Features:**

Body material: technopolymer
 Protection degree: IP54 acc. to EN 60529
 Tightening torque: 0.8 ... 1 Nm

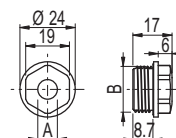

Notes: Use a socket wrench for tightening.

Article	Description	A	B
VF PFM20C8N	M20x1.5 chock plug for cables from Ø 8...Ø 12 mm	7.5	M20x1.5
VF PFM20C4N	M20x1.5 chock plug for cables from Ø 4...Ø 8 mm	3.5	M20x1.5

Tampering protection for M12 connectors

Packs of 10 pcs.

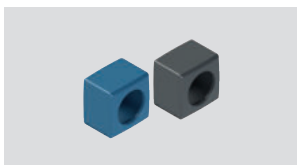

Features:

These tampering protections are composed of two identical snap-on shells. They are applied to the device connectors, thereby making them inaccessible. The shells can only be removed by breaking them. Thus, any attempt to tamper with them will be immediately evident.

The protection can be installed quickly and easily by pressing the two shells lightly into place.

The protections are suitable for all devices with an M12 connector (e.g. NS, ST, SR series) but they can also be used for junctions between cables with male - female connectors.

A version made of detectable plastic is available for the food industry, and it can easily be detected during the process using common optical vision technologies, X-rays or metal detectors.

Installation:

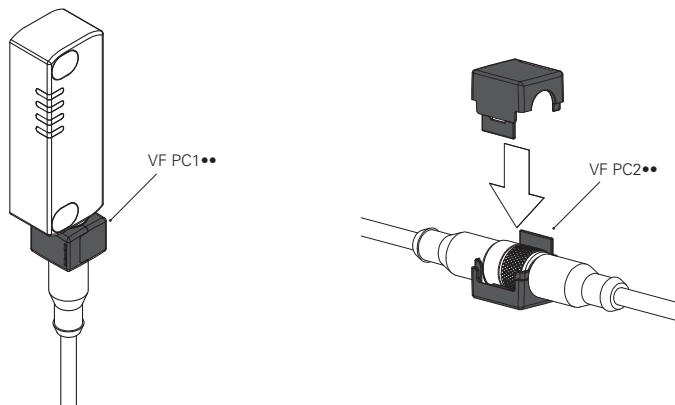

Article	Description	Colour / material
VF PC1A9	Tamper-proof protection for device-side connector	● Grey technopolymer
VF PC2A9	Tamper-proof protection for male - female connector	● Grey technopolymer
VF PC1B6	Tamper-proof protection for device-side connector	● Blue detectable technopolymer
VF PC2B6	Tamper-proof protection for male - female connector	● Blue detectable technopolymer

LED signalling lights

Packs of 5 pcs.



These signalling lights with high luminosity LEDs are used for signalling that an electric contact has changed its state inside the switch. They can be installed on switches of the FL, FX, FZ, FW, FG, NG or FS series by screwing them on one of the conduit entries not used for electric cables. They can be used for many different purposes: for example, to signal, from a distance, whether the switch has been actuated; whether the guard has closed correctly; or whether the guard is locked or unlocked.

The inner part can rotate in such a way that it can be wired and screwed on the switch without any risk of twisting the wires.

Features:

Protection degree:

IP67 acc. to EN 60529

Ambient temperature:

IP69K acc. to ISO 20653

Operating voltage U_n :

-25°C ... +70°C

24 Vac/dc (10 mA)

120 Vac (20 mA)

230 Vac (20 mA)

Tolerance on the

supply voltages:

 $\pm 15\%$ of U_n

Operating current:

10 mA

Connection system:

PUSH-IN spring type

Cross-section of rigid/flexible wires w. wire-end sleeve:

min. 1 x 0.34 mm² (1 x AWG 24)max. 1 x 1.5 mm² (1 x AWG 16)

Wire cross-section with pre-insulated wire-end sleeve:

min. 1 x 0.34 mm² (1 x AWG 24)max. 1 x 0.75 mm² (1 x AWG 18)

Tightening torque:

1.2 ... 2 Nm

Wire stripping length (x):

min.: 8 mm

max.: 12 mm

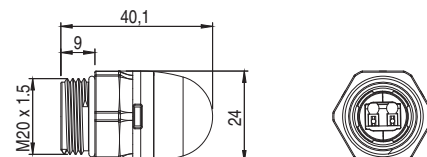

Application examples

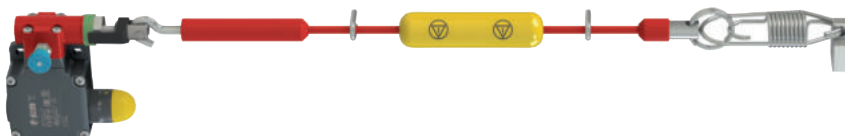

Status indicator for safety rope switches

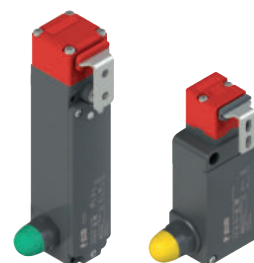

Indication of unlocked door

Code structure

Attention! The feasibility of a code number does not mean the effective availability of a product. Please contact our sales office

VF SL1A3PA1

Operating voltage

1	24 Vac/dc
3	120 Vac
4	230 Vac

Type of light source

A	standard LED with continuous light
---	------------------------------------

Body design

A	Total height 40 mm, spherical lens, threading M20x1.5mm
---	---

Connection type

P	PUSH-IN terminal strip
---	------------------------

Lens colour

2	White
3	Red
4	Green
5	Yellow

Stock items

VF SL1A3PA1
VF SL1A5PA1

All values in the drawings are in mm

→ The 2D and 3D files are available at www.pizzato.com

Fixing plates



Metal fixing plate, for fixing rope switches on the ceiling.

The plate is provided with bore holes for fastening switches of the FD, FL, FC, FP, FR, FM, FZ, FX, FK series. It is supplied without screws.

Article	Description
VF SFP2	Ceiling fixing plate

Fixing plates

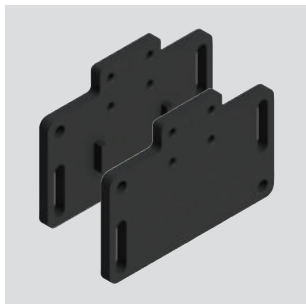

Fixing plate (complete with fastening screws) provided with long slots for adjusting the operating point.

Each plate is provided with two pairs of mounting holes, one for standard switches and one for switches with reset device. The actuator thus always has the same actuating point.

Article	Description
VF SFP1	Fixing plate (FR series)
VF SFP3	Fixing plate (FX series)

Torx safety screws

Packs of 10 pcs.



Pan head screws with Torx fitting and pin, stainless steel.

Use a thread locker where required for applications acc. to. EN ISO 14119.

Article	Description
VF VAM4X10BX-X	M4x10 screw, with Torx T20 fitting, AISI 304
VF VAM4X15BX-X	M4x15 screw, with Torx T20 fitting, AISI 304
VF VAM4X20BX-X	M4x20 screw, with Torx T20 fitting, AISI 304
VF VAM4X25BX-X	M4x25 screw, with Torx T20 fitting, AISI 304
VF VAM4X30BX-X	M4x30 screw, with Torx T20 fitting, AISI 304
VF VAM5X10BX-X	M5x10 screw, with Torx T25 fitting, AISI 304
VF VAM5X15BX-X	M5x15 screw, with Torx T25 fitting, AISI 304
VF VAM5X20BX-X	M5x20 screw, with Torx T25 fitting, AISI 304
VF VAM5X25BX-X	M5x25 screw, with Torx T25 fitting, AISI 304
VF VAM5X35BX-X	M5x35 screw, with Torx T25 fitting, AISI 304
VF VAM5X45BX-X	M5x45 screw, with Torx T25 fitting, AISI 304

OneWay safety screws

Packs of 10 pcs.



Pan head screws with OneWay fitting in stainless steel.

This screw type cannot be removed or tampered with using common tools. Ideal for fixing safety device actuators in accordance with EN ISO 14119.

Article	Description
VF VAM4X10BW-X	M4x10 screw, with OneWay fitting, AISI 304
VF VAM4X15BW-X	M4x15 screw, with OneWay fitting, AISI 304
VF VAM4X20BW-X	M4x20 screw, with OneWay fitting, AISI 304
VF VAM4X25BW-X	M4x25 screw, with OneWay fitting, AISI 304
VF VAM5X10BW-X	M5x10 screw, with OneWay fitting, AISI 304
VF VAM5X15BW-X	M5x15 screw, with OneWay fitting, AISI 304
VF VAM5X20BW-X	M5x20 screw, with OneWay fitting, AISI 304
VF VAM5X25BW-X	M5x25 screw, with OneWay fitting, AISI 304

Bits for Torx safety screws

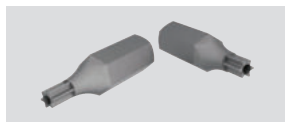

Bits for Torx safety screws with pin, with 1/4" hexagonal connection.

Article	Description
VF VAIT1T20	Bits for M4 screws with Torx T20 fitting
VF VAIT1T25	Bits for M5 screws with Torx T25 fitting
VF VAIT1T30	Bits for M6 screws with Torx T30 fitting

→ The 2D and 3D files are available at www.pizzato.com

Junction box for series connection of up to 4 devices



This accessory allows easy and precise series connection of up to 4 devices. Thanks to the numbered terminals and to the internal circuit, it is sufficient to connect the conductors in the slots provided with the practical and fast PUSH-IN spring connections. Thanks to the four internal microswitches, it is possible to easily and immediately direct the device signalling outputs (open or closed, locked or unlocked) to one of the four available auxiliary channels and then manage the information independently for each channel through a PLC.

Features:

- Material:** Self-extinguishing shock-proof polycarbonate with double insulation, UV-resistant and glass fibre reinforced
- Material of the screws:** Stainless steel
- Protection degree:** IP67 acc. to EN 60529, IP69K acc. to ISO 20653, with cable gland of equal or higher protection degree
- Conduit entries:** 2x M20 - 1/2 NPT knock-out side entries
2x M20 - 1/2 NPT - M25 knock-out side entries
2x M16 knock-out base entries
- Ambient temperature:** -40°C ... +80°C
- Tightening torque of the cover screws:** 1 ... 1.4 Nm
- Connection system:** PUSH-IN spring type
- Cross-section of rigid/flexible wires w. wire-end sleeve:** min. 1 x 0.34 mm² (1 x AWG 24)
max. 1 x 1.5 mm² (1 x AWG 16)
- Wire cross-section with pre-insulated wire-end sleeve:** min. 1 x 0.34 mm² (1 x AWG 24)
max. 1 x 0.75 mm² (1 x AWG 18)
- Wire stripping length (x):** min.: 8 mm
max.: 12 mm

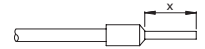

Pin assignment

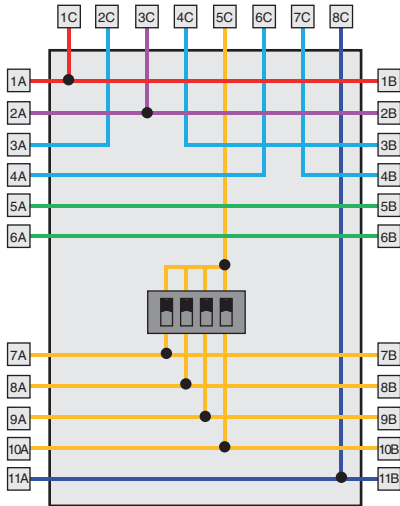

Article	Description
VF CY302P0	Junction box for series connection of up to 4 devices

Terminal box	Connection	Terminal box	Connection
1A / 1B	A1 Supply input +24 Vdc	1C	A1 Supply input +24 Vdc
2A / 2B	A2 Supply input 0 V	2C	OS1 Safety output
3A / 3B	OS1 / IS1 Safety output / safety input	3C	A2 Supply input 0 V
4A / 4B	OS2 / IS2 Safety output / safety input	4C	IS1 Safety input
5A / 5B	Auxiliary connection	5C	O3 Signalling output, actuator inserted
6A / 6B	Auxiliary connection	6C	O4 Signalling output, actuator inserted and locked
7A / 7B	O AUX1 Auxiliary output Oaux1	7C	OS2 Safety output
8A / 8B	O AUX2 Auxiliary output Oaux2	8C	IS2 Safety input
9A / 9B	O AUX3 Auxiliary output Oaux3	I4	I4 Solenoid activation input
10A / 10B	O AUX4 Auxiliary output Oaux4		
11A / 11B	I4 Solenoid activation input		

Example of series connection of 4 NG series switches

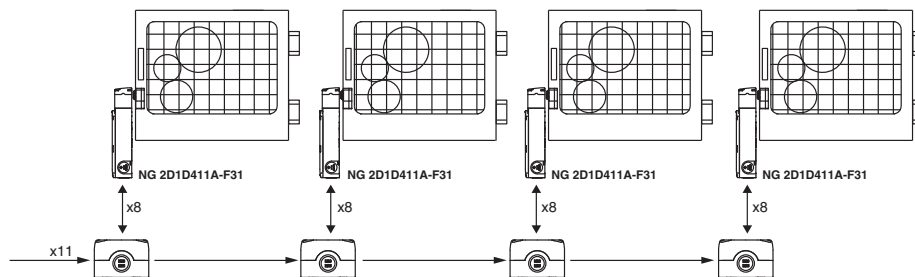

Wiring diagram

