

Selection diagram

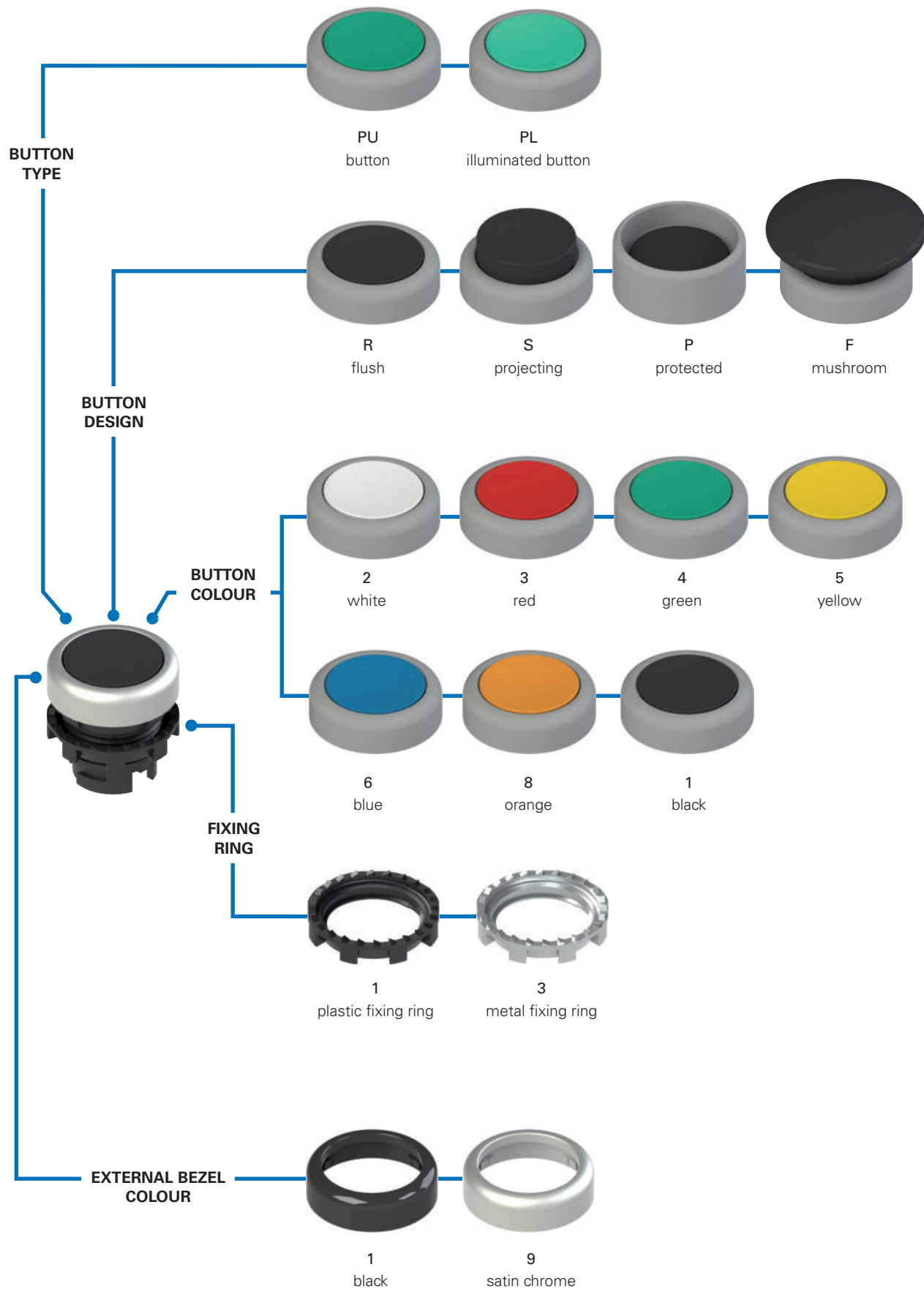

Code structure for buttons

Attention! The feasibility of a code number does not mean the effective availability of a product. Please contact our sales office.

article options
E2 1PU2R1210-T6

Fixing ring and shaped ring	
1	plastic fixing ring (standard)
2	plastic fixing ring and shaped ring
3	metal fixing ring
4	metal fixing ring and shaped ring

Button function	
1	maintained
2	spring-return (standard)
4	spring-return for 4-slot base

Button design	
R	flush
S	projecting
P	protected
F	mushroom

Button colour	
0	without lens
1	black
2	white
3	red
4	green
5	yellow
6	blue
8	orange

Ambient temperature	
	-25°C ... +80°C (standard), spring-return button
	-25°C ... +50°C (standard), maintained button
T6	-40°C ... +80°C spring-return button
	-40°C ... +50°C maintained button

Button engraving	
0	no engraving
L1	O
L2	I
...

Other engravings on request. See page 159

External bezel colour	
1	black
9	satin chrome

Button diameter	
2	Ø 20 mm
4	Ø 36 mm (mushroom only)

Code structure for illuminated buttons

Attention! The feasibility of a code number does not mean the effective availability of a product. Please contact our sales office.

article options
E2 1PL2R2210-T6

Fixing ring and shaped ring	
1	plastic fixing ring (standard)
2	plastic fixing ring and shaped ring
3	metal fixing ring
4	metal fixing ring and shaped ring

Button function	
1	maintained
2	spring-return (standard)

Button design	
R	flush
S	projecting
P	protected
F	mushroom

Button colour	
0	without lens
2	white
3	red
4	green
5	yellow
6	blue
8	orange

Ambient temperature	
	-25°C ... +80°C (standard), spring-return button
	-25°C ... +50°C (standard), maintained button
T6	-40°C ... +80°C spring-return button
	-40°C ... +50°C maintained button

Button engraving	
0	no engraving
L1	O
L2	I
...

Other engravings on request. See page 159.

External bezel colour	
1	black
9	satin chrome

Button diameter	
2	Ø 20 mm
4	Ø 36 mm (mushroom only)



Main features

- Protection degrees IP67 and IP69K
- 4 different shapes
- 7 colours available
- -40°C versions
- Maintained or spring-return version

Quality marks:



IMQ approval: CA02.04805
 UL approval: E131787
 EAC approval: RU C-IT.YT03.B.00035/19

Technical data

General data

Protection degree:	IP67 acc. to EN 60529 IP69K acc. to ISO 20653
Ambient temperature:	-25°C ... +80°C (standard) -40°C ... +80°C (T6 option)
Spring-return button	-25°C ... +50°C (standard) -40°C ... +50°C (T6 option)
Maintained button	30,000,000 (spring-return button) 2,000,000 (maintained button)
Safety parameter B _{10D} :	15 million operating cycles (spring-return button) 1 million operating cycles (maintained button)
Mechanical endurance:	3600 operating cycles/hour
Max. actuation frequency:	3.7 N (without contacts) (spring-return button) 4.4 N (without contacts) (maintained button)
Actuating force at limit of travel:	5 mm
Maximum travel:	2 ... 2.5 Nm
Tightening torque of the fixing ring:	See page 163
Utilization requirements:	

In compliance with standards:

IEC 60947-1, IEC 60947-5-1, IEC 60204-1, EN 60947-1, EN 60947-5-1, EN 60204-1, EN IEC 63000 UL 508, CSA 22-2 No. 14

⚠ Installation for safety applications:

Use only contact blocks marked with the symbol . The safety circuit must always be connected to **NC contacts** (normally closed contacts: .1-2)

Compliance with the requirements of:

Low Voltage Directive 2014/35/EU, EMC Directive 2014/30/EU, RoHS Directive 2011/65/EU

Positive contact opening in conformity with standards:

IEC 60947-5-1, EN 60947-5-1.

Features approved by UL

For Use on a Flat Surface of a Type 1, 4X, 12 and 13
 Tightening torque 2.0 Nm

General data

Protection degrees IP67 and IP69K

IP69K
IP67

These devices are designed to be used in the toughest environmental conditions and they pass the IP67 immersion test acc. to EN 60529. They can therefore be used in all environments where maximum protection degree of the housing is required. Due to

their special design, these devices are suitable for use in equipment subjected to cleaning with high pressure hot water jets. These devices meet the IP69K test requirements according to ISO 20653 (water jets with 100 bar and 80°C).

Metal fixing ring



The fixing ring in metal is particularly suitable for those applications which require tighter fitting of the panel-mounted device, such as for example in metal panels having holes without reference notches.

Shaped ring

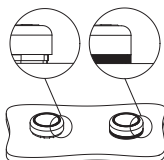

The shaped ring can be used when no label holder or other devices are applied; it prevents dirt and other residues from settling between the button and the panel or housing.

This turns out to be particularly useful in the sectors where high standards of cleanness and hygiene are required.

Functions

Depending on the type of application, the EROUND line buttons of Pizzato Elettrica are available in two versions: the one with maintained function (once the button is pressed, a second manual intervention is necessary for unlocking) and the one with spring-return function (the button is not maintained locked).



Customisable



In order to satisfy various customer requests and demands, Pizzato Elettrica offers the possibility to customize the control and signalling devices of the EROUND line: the bezels can be requested with different colours (black and satin chrome), whereas the lenses can be customized with a wide range of writings, symbols, and colours.

Extended temperature range









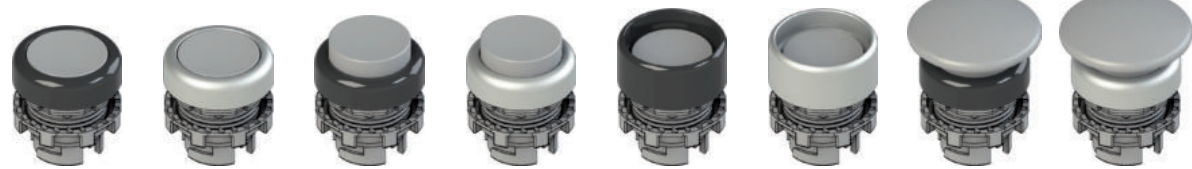



-40°C

These devices are also available in a special version suitable for an ambient operating temperature range from -40°C up to +80°C.

They can therefore be used for applications in cold stores, sterilisers and other equipment with low temperature environments. The special materials used to produce these versions retain their characteristics even under these conditions, thereby expanding the installation possibilities.

Selection table for buttons













Colour and engraving actuator	Flush		Projecting		Protected		Mushroom	
	black bezel	satin chr. bezel	black bezel	satin chr. bezel	black bezel	satin chr. bezel	black bezel	satin chr. bezel
 without lens	E2 1PU2R0210	E2 1PU2R0290	Same article, flush button	Same article, flush button	E2 1PU2P0210	E2 1PU2P0290	-	-
 black	E2 1PU2R1210	E2 1PU2R1290	E2 1PU2S1210	E2 1PU2S1290	E2 1PU2P1210	E2 1PU2P1290	E2 1PU2F1410	E2 1PU2F1490
 white	E2 1PU2R2210	E2 1PU2R2290	E2 1PU2S2210	E2 1PU2S2290	E2 1PU2P2210	E2 1PU2P2290	E2 1PU2F2410	E2 1PU2F2490
 red	E2 1PU2R3210	E2 1PU2R3290	E2 1PU2S3210	E2 1PU2S3290	E2 1PU2P3210	E2 1PU2P3290	E2 1PU2F3410	E2 1PU2F3490
 green	E2 1PU2R4210	E2 1PU2R4290	E2 1PU2S4210	E2 1PU2S4290	E2 1PU2P4210	E2 1PU2P4290	E2 1PU2F4410	E2 1PU2F4490
 yellow	E2 1PU2R5210	E2 1PU2R5290	E2 1PU2S5210	E2 1PU2S5290	E2 1PU2P5210	E2 1PU2P5290	E2 1PU2F5410	E2 1PU2F5490
 blue	E2 1PU2R6210	E2 1PU2R6290	E2 1PU2S6210	E2 1PU2S6290	E2 1PU2P6210	E2 1PU2P6290	E2 1PU2F6410	E2 1PU2F6490
 orange	E2 1PU2R8210	E2 1PU2R8290	E2 1PU2S8210	E2 1PU2S8290	E2 1PU2P8210	E2 1PU2P8290	E2 1PU2F8410	E2 1PU2F8490
 red	E2 1PU2R321L1	E2 1PU2R329L1	E2 1PU2S321L1	E2 1PU2S329L1	-	-	E2 1PU2F341L1	E2 1PU2F349L1
 green	E2 1PU2R421L2	E2 1PU2R429L2	E2 1PU2S421L2	E2 1PU2S429L2	E2 1PU2P421L2	E2 1PU2P429L2	E2 1PU2F441L2	E2 1PU2F449L2
 black	E2 1PU2R121L1	E2 1PU2R129L1	E2 1PU2S121L1	E2 1PU2S129L1	-	-	E2 1PU2F141L1	E2 1PU2F149L1
 white	E2 1PU2R221L2	E2 1PU2R229L2	E2 1PU2S221L2	E2 1PU2S229L2	E2 1PU2P221L2	E2 1PU2P229L2	E2 1PU2F241L2	E2 1PU2F249L2

For ordering a maintained button replace 1PU2 with 1PU1 in the respective article code.

Example: E2 1PU2R0210 → E2 1PU1R0210

Selection table for illuminated buttons



Actuator colour and engraving	Flush		Projecting		Protected		Mushroom	
	black bezel	satin chr. bezel	black bezel	satin chr. bezel	black bezel	satin chr. bezel	black bezel	satin chr. bezel
 without lens	E2 1PL2R0210	E2 1PL2R0290	Same article, flush button	Same article, flush button	E2 1PL2P0210	E2 1PL2P0290	-	-
 white	E2 1PL2R2210	E2 1PL2R2290	E2 1PL2S2210	E2 1PL2S2290	E2 1PL2P2210	E2 1PL2P2290	E2 1PL2F2410	E2 1PL2F2490
 red	E2 1PL2R3210	E2 1PL2R3290	E2 1PL2S3210	E2 1PL2S3290	E2 1PL2P3210	E2 1PL2P3290	E2 1PL2F3410	E2 1PL2F3490
 green	E2 1PL2R4210	E2 1PL2R4290	E2 1PL2S4210	E2 1PL2S4290	E2 1PL2P4210	E2 1PL2P4290	E2 1PL2F4410	E2 1PL2F4490
 yellow	E2 1PL2R5210	E2 1PL2R5290	E2 1PL2S5210	E2 1PL2S5290	E2 1PL2P5210	E2 1PL2P5290	E2 1PL2F5410	E2 1PL2F5490
 blue	E2 1PL2R6210	E2 1PL2R6290	E2 1PL2S6210	E2 1PL2S6290	E2 1PL2P6210	E2 1PL2P6290	E2 1PL2F6410	E2 1PL2F6490
 orange	E2 1PL2R8210	E2 1PL2R8290	E2 1PL2S8210	E2 1PL2S8290	E2 1PL2P8210	E2 1PL2P8290	E2 1PL2F8410	E2 1PL2F8490
 red	E2 1PL2R321L1	E2 1PL2R329L1	E2 1PL2S321L1	E2 1PL2S329L1	-	-	E2 1PL2F341L1	E2 1PL2F349L1
 green	E2 1PL2R421L2	E2 1PL2R429L2	E2 1PL2S421L2	E2 1PL2S429L2	E2 1PL2P421L2	E2 1PL2P429L2	E2 1PL2F441L2	E2 1PL2F449L2
 white	E2 1PL2R221L1	E2 1PL2R229L1	E2 1PL2S221L1	E2 1PL2S229L1	-	-	E2 1PL2F241L1	E2 1PL2F249L1
 white	E2 1PL2R221L2	E2 1PL2R229L2	E2 1PL2S221L2	E2 1PL2S229L2	E2 1PL2P221L2	E2 1PL2P229L2	E2 1PL2F241L2	E2 1PL2F249L2

For ordering a maintained button replace 1PL2 with 1PL1 in the respective article code.

Example: E2 1PL2R0210 → E2 1PL1R0210

Complete units with buttons

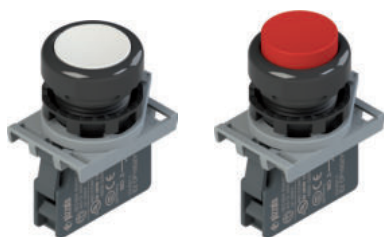

Colour and engraving actuator	Contacts			Flush	
	pos. 2	pos. 3	pos. 1	black bezel	
black	-	1NO	-	E2 AC-DXBC1204 E2 1PU2R1210 + E2 1BAC11 + E2 CP10G2V1	
white	-	1NO	-	E2 AC-DXBC1200 E2 1PU2R2210 + E2 1BAC11 + E2 CP10G2V1	
red	-	1NC	-	E2 AC-DXBC1208 E2 1PU2R3210 + E2 1BAC11 + E2 CP01G2V1	E2 AC-DXBC1209 E2 1PU2S3210 + E2 1BAC11 + E2 CP01G2V1
green	-	1NO	-	E2 AC-DXBC1201 E2 1PU2R4210 + E2 1BAC11 + E2 CP10G2V1	
yellow	-	1NO	-	E2 AC-DXBC1206 E2 1PU2R5210 + E2 1BAC11 + E2 CP10G2V1	
blue	-	1NO	-	E2 AC-DXBC1207 E2 1PU2R6210 + E2 1BAC11 + E2 CP10G2V1	
red	-	1NC	-	E2 AC-DXBC1211 E2 1PU2R321L1 + E2 1BAC11 + E2 CP01G2V1	E2 AC-DXBC1212 E2 1PU2S321L1 + E2 1BAC11 + E2 CP01G2V1
green	-	1NO	-	E2 AC-DXBC1210 E2 1PU2R421L2 + E2 1BAC11 + E2 CP10G2V1	
black	-	1NC	-	E2 AC-DXBC1227 E2 1PU2R121L1 + E2 1BAC11 + E2 CP01G2V1	
white	-	1NO	-	E2 AC-DXBC1226 E2 1PU2R221L2 + E2 1BAC11 + E2 CP10G2V1	

Other combinations on request.

→ For data regarding contact blocks and LED units, please see the respective chapters.

Complete units with illuminated buttons



Colour and engraving actuator	Contacts			Flush	
	pos. 2	pos. 3	pos. 1	black bezel	
white	1NC	LED	1NO	E2 AC-DXBC0400 E2 1PL2R2210 + E2 1BAC11 + E2 CP01G2V1 + E2 LP1A2V1 + E2 CP10G2V1	
red	1NC	LED	1NO	E2 AC-DXBC0402 E2 1PL2R3210 + E2 1BAC11 + E2 CP01G2V1 + E2 LP1A3V1 + E2 CP10G2V1	
green	1NC	LED	1NO	E2 AC-DXBC0401 E2 1PL2R4210 + E2 1BAC11 + E2 CP01G2V1 + E2 LP1A4V1 + E2 CP10G2V1	
yellow	1NC	LED	1NO	E2 AC-DXBC0404 E2 1PL2R5210 + E2 1BAC11 + E2 CP01G2V1 + E2 LP1A2V1 + E2 CP10G2V1	
blue	1NC	LED	1NO	E2 AC-DXBC0403 E2 1PL2R6210 + E2 1BAC11 + E2 CP01G2V1 + E2 LP1A6V1 + E2 CP10G2V1	

Other combinations on request.

Dimensions

All values in the drawings are in mm

Flush button

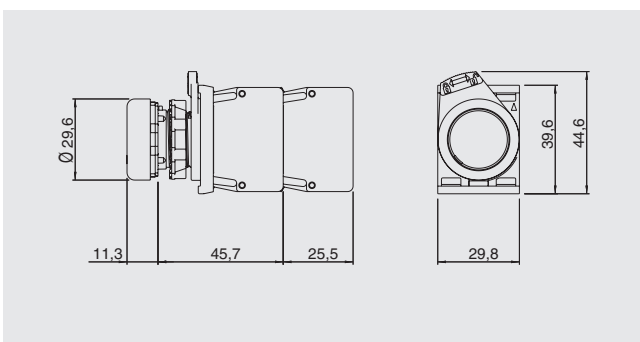

Projecting button

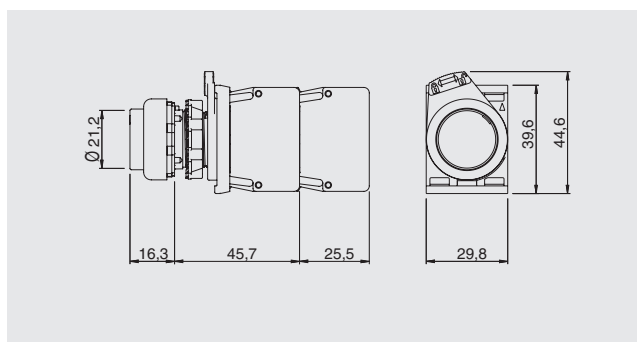

Protected button

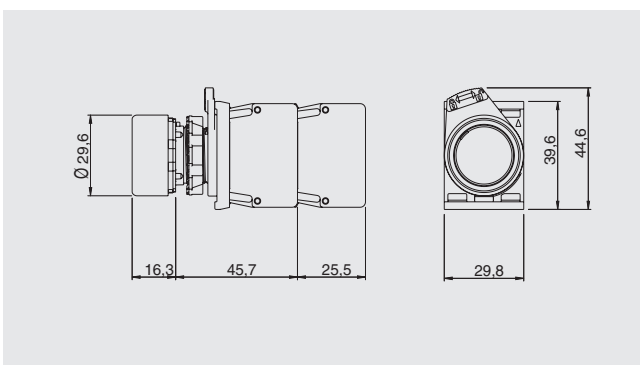

Mushroom button

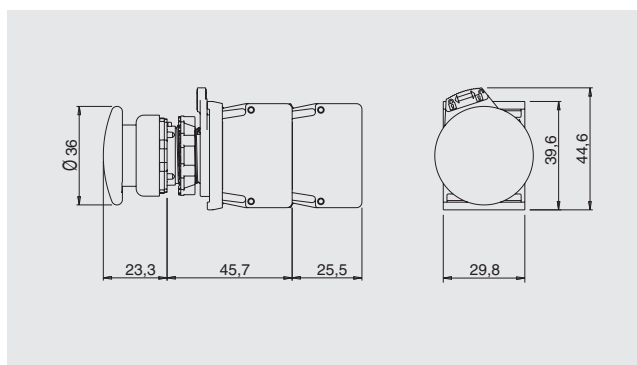





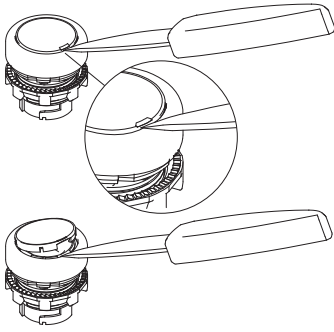













→ The 2D and 3D files are available at www.pizzato.com

Lenses for E2 •PU buttons and E2 •PL illuminated buttons



















The buttons and the illuminated buttons feature replaceable lenses.
To remove the lenses, leverage them with a pointed object near the reference notch on the external diameter of the lens itself.



Lenses without engraving				
Article	Type	Description	Colours	Pieces/ package
VE LP21R10		Lens for flush button, black, without engraving		10
VE LP22R20		Lens for flush button, white, without engraving		10
VE LP22R30		Lens for flush button, red, without engraving		10
VE LP22R40		Lens for flush button, green, without engraving		10
VE LP22R50		Lens for flush button, yellow, without engraving		10
VE LP22R60		Lens for flush button, blue, without engraving		10
VE LP22R80		Lens for flush button, orange, without engraving		10
VE LP22RA0			7 lenses for flush button without engraving, colours: black, white, red, green, yellow, blue and orange	
VE LP21S10		Lens for projecting button, black, without engraving		10
VE LP22S20		Lens for projecting button, white, without engraving		10
VE LP22S30		Lens for projecting button, red, without engraving		10
VE LP22S40		Lens for projecting button, green, without engraving		10
VE LP22S50		Lens for projecting button, yellow, without engraving		10
VE LP22S60		Lens for projecting button, blue, without engraving		10
VE LP22S80		Lens for projecting button, orange, without engraving		10
VE LP22SA0			7 lenses for protruding button without engraving, colours: black, white, red, green, yellow, blue and orange	



Lenses with engraving				
Article	Type	Description	Colours	Pieces/ package
VE LP21R1●●●		Lens for flush button, black, with engraving		1
VE LP22R2●●●		Lens for flush button, white, with engraving		1
VE LP22R3●●●		Lens for flush button, red, with engraving		1
VE LP22R4●●●		Lens for flush button, green, with engraving		1
VE LP22R5●●●		Lens for flush button, yellow, with engraving		1
VE LP22R6●●●		Lens for flush button, blue, with engraving		1
VE LP22R8●●●		Lens for flush button, orange, with engraving		1
VE LP21S1●●●			Lens for projecting button, black, with engraving	
VE LP22S2●●●	Lens for projecting button, white, with engraving			1
VE LP22S3●●●	Lens for projecting button, red, with engraving			1
VE LP22S4●●●	Lens for projecting button, green, with engraving,			1
VE LP22S5●●●	Lens for projecting button, yellow, with engraving			1
VE LP22S6●●●	Lens for projecting button, blue, with engraving			1
VE LP22S8●●●	Lens for projecting button, orange, with engraving			1

The black lens cannot be used with illuminated buttons.

For ordering lenses for buttons with engraving:

replace the dots ●●● in the article codes with the engraving code reported on the table at page 159.

Example: white lens for flush button with "O" engraving.

VE LP22R2●●● → VE LP22R2L1

Minimum distances for installation

All values in the drawings are in mm

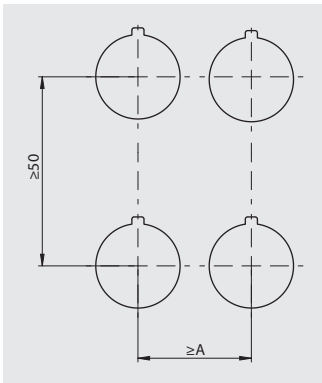

3-slot mounting adapter	
Button type	A
flush	30 mm
projecting	30 mm
protected	30 mm
mushroom	40 mm
4-slot mounting adapter	
Button type	A
flush	40 mm
projecting	40 mm
protected	40 mm
mushroom	40 mm

Maximum number of contact blocks

3-slot mounting adapter

4-slot mounting adapter

Spring-return buttons
E2 •PU2•••••

Maintained buttons
E2 •PU1•••••

Illuminated spring-return buttons
E2 •PL2•••••

Illuminated maintained buttons
E2 •PL1•••••

Spring-return buttons
E2 •PU4•••••

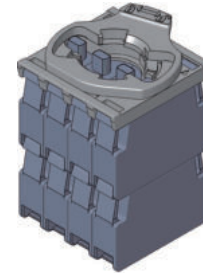
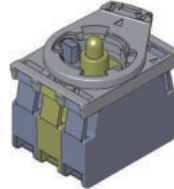
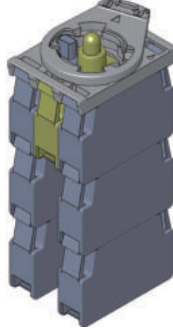
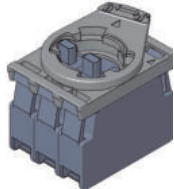
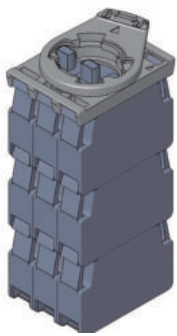

maximum number:
9 contact blocks
3 levels

maximum number:
3 contact blocks
1 level

maximum number:
6 contact blocks
3 levels

maximum number:
2 contact blocks
1 level

maximum number:
8 contact blocks
2 levels

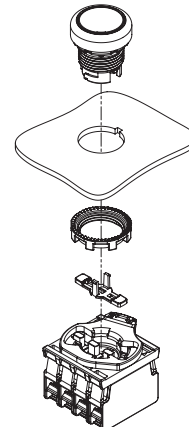
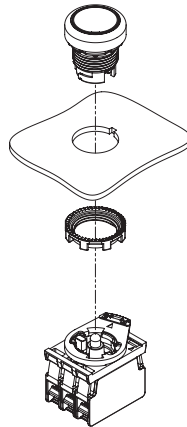
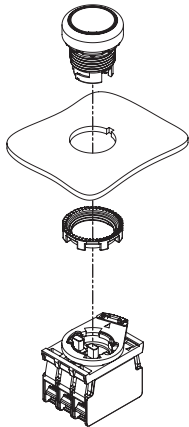

contact block



LED unit

The mounting of the actuator for 4-slot base must be carried out after fixing the button.

Closing cap Packs of **10 pcs.**



Article	Description
VE AS1211	Central closing cap for illuminated button E2 •PL●●●●●●. For 3-slot mounting adapters.

It closes the central hole of the illuminated button and makes it possible to actuate a contact instead of the LED.

Actuator for 4-slot base Packs of **10 pcs.**



Article	Description
VE AS1218	Closed long actuator for 4-slot mounting adapter. It must be installed after fixing the button to the wall. For E2 •PU●●●●●● buttons

Shaped ring Packs of **50 pcs.**



Article	Description
VE GP12H1A	Shaped ring for single device

Not applicable in presence of label holders, adapters from Ø 22 to Ø 30 mm, guards or protection caps.

Protection cap Packs of **10 pcs.**



Article	Description
VE CA1A1	Protection cap for flush button (panel width from 1 to 5 mm)
VE CA1B1	Protection cap for single projecting button (panel width from 1 to 5 mm)

Not applicable in presence of shaped rings, label holders, adapters from Ø 22 to Ø 30 mm or protection guards.

Fixing ring Packs of **20 pcs.**



Article	Description
VE GF720A	Metal fixing ring

Accessories

➔ More ACCESSORIES on page 155